

Smart Lock  
Model No. U009  
Installation instruction



# Catalogue

< 1 > Installation guide

<11> How to use

<13> APP guide

<31> Low power

<31> Restore Factory Settings

<32> Troubleshooting

<33> Appendix

# Installation guide

## Accessories list

A.Screw-fixed plate

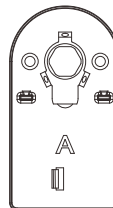

B.Adhesive-fixed plate

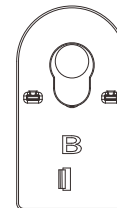

C.Smart lock

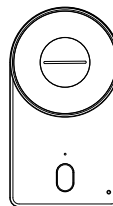

D.Allen key



E.Adhesive magnet



F.Needle



# 1 Installation Check

This user manual is for the following cylinders:

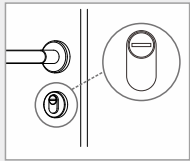

UK oval cylinder

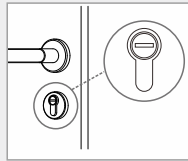

Euro profile cylinder

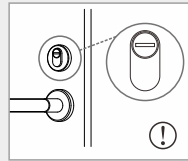

Oval Cylinder  
Ⓢ Please refer to the appendix

Lock your door from the inside with a key

**A** Pls ensure your lock cylinder has emergency function and can be locked on both sides.

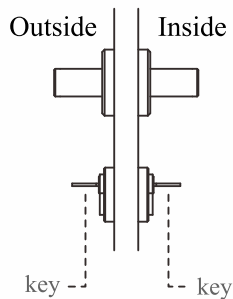

<2>

**B** The inner and outer key be moved synchronously.

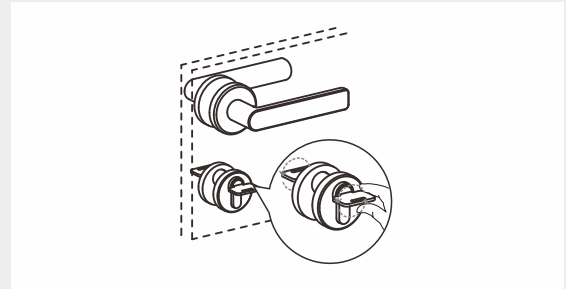

**C** The cylinder does not protrude more than **30mm** from the door.

**D** Requirement of key

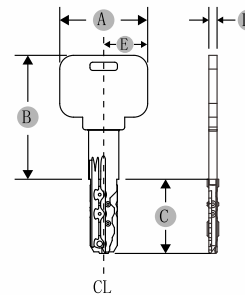

Width of key **A**  $\leq 35\text{mm}$   
(width requirement of symmetry key)

Width requirement of asymmetry key:

- Length from center line CL to key edge **E**  $\leq 17.5\text{mm}$
- Length of shoulder side **B**  $\leq 45\text{mm}$
- Key thickness **D**  $\leq 45\text{mm}$

<3>

## 2 Mounting plate

A Mounting with a screw-fixed plate (mounting plate A).

a

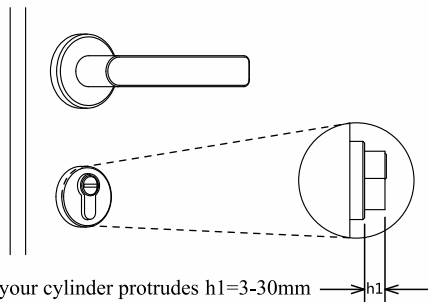

How far your cylinder protrudes  $h_1=3-30\text{mm}$

b

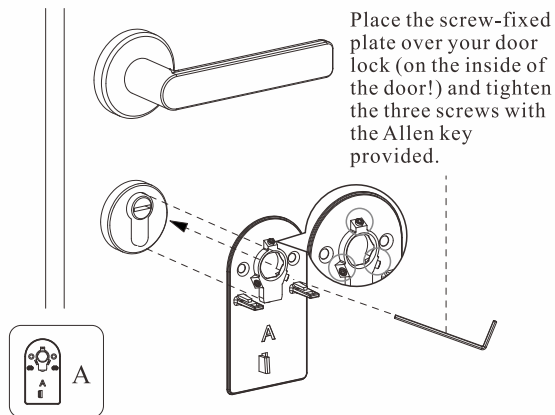

<4>

B Mounting with an adhesive-fixed plate (mounting plate B).

a

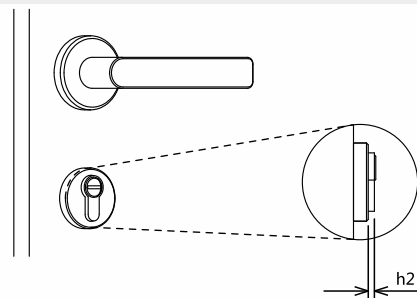

How far your cylinder protrudes  $h_2=0-3\text{mm}$

b

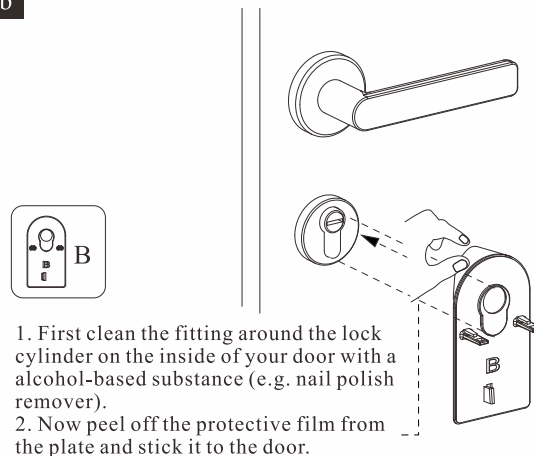

<5>

### 3 Insert the key

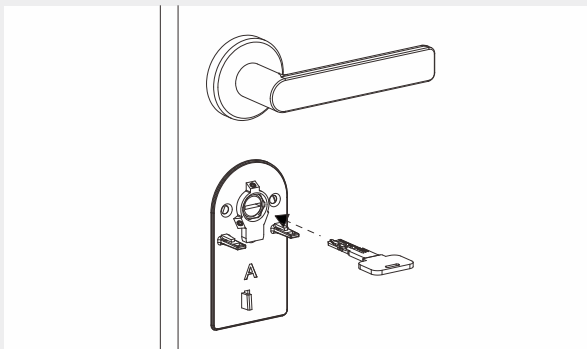

### 4 Installation of smart lock

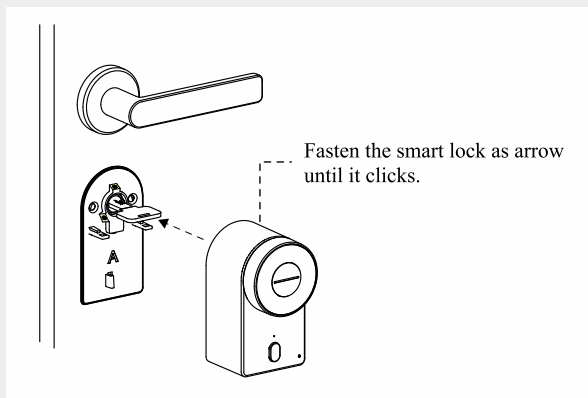

<6>

### 5 Installation of magnet

Peel off the protective film from the magnet.

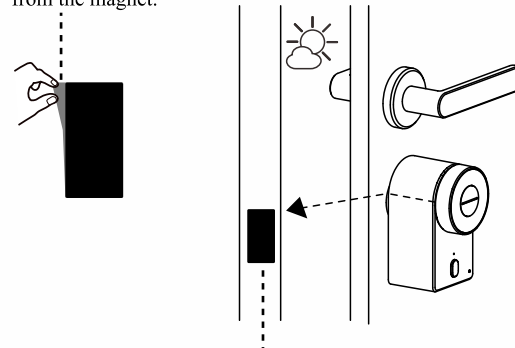

Stick it to door frame as photo

Function of magnet

- ① to judge direction of door opening
- ② to achieve autolock function

NOTE: effective distance  $F \leq 45\text{mm}$

Pls turn to TTLOCK APP (refer to setting of left and right door) if magnet is not working

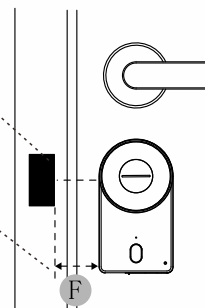

<7>

## 6 Battery installation

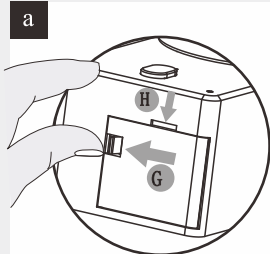

Pry buckle **G** and groove **H** with hand

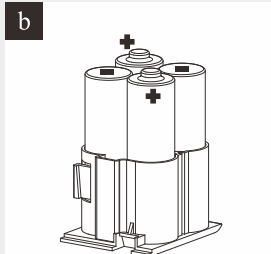

Install battery as photo  
(Pay attention to electrode)

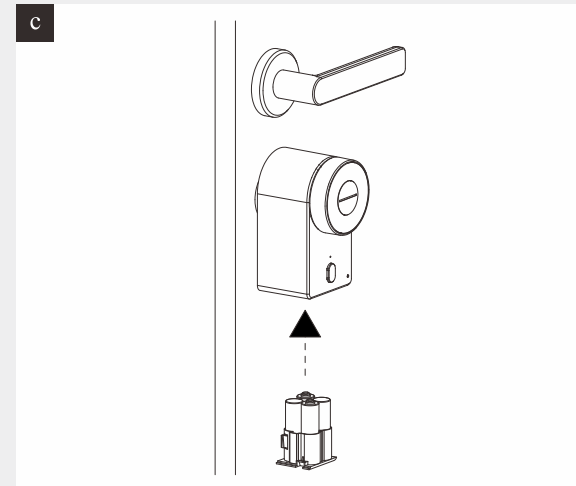

<8>

## 7 Testing

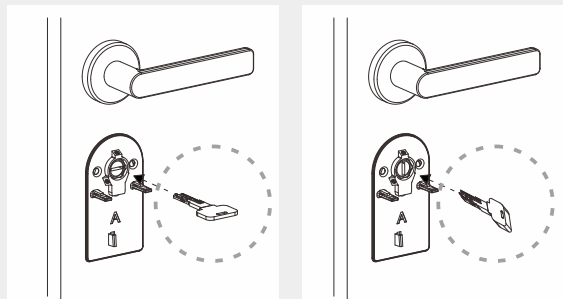

Confirm whether the key is  
horizontal or vertical

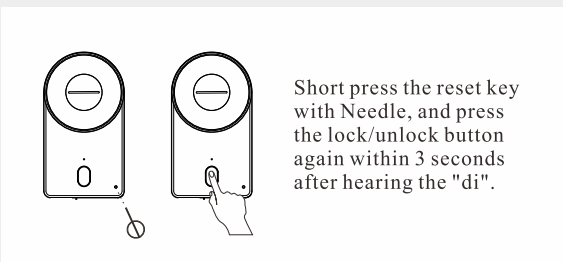
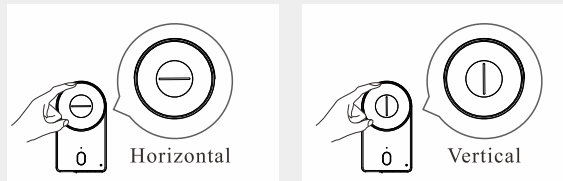

Short press the reset key  
with Needle, and press  
the lock/unlock button  
again within 3 seconds  
after hearing the "di".

<9>

## 7 How to remove the smart lock?

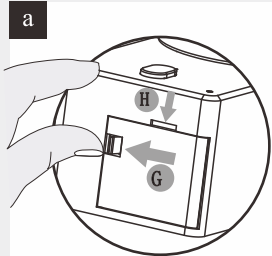

Pry buckle **G** and groove **H** with hand

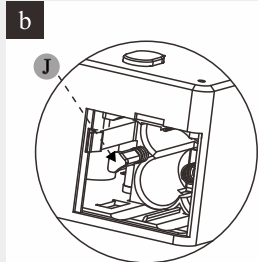

Press the button **J**, then the Smart Lock is removed.

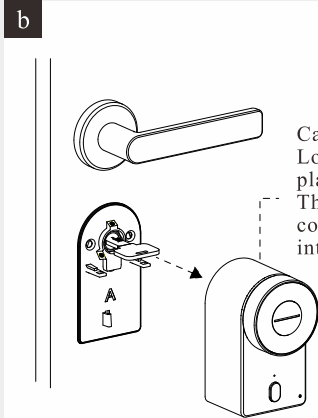

Carefully remove the Smart Lock from the mounting plate. Then reinsert the battery compartment/Power Pack into the Smart Lock.

## How to Use

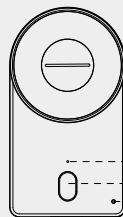

- M** LED light: green light flashing is start/red light flashing is stop
- L** One-button lock&unlock: lock/unlock button
- K** Set/reset button:
  - 1.Short press Set/Reset button is to match bluetooth with needle(blue light flashing)
  - 2.Long press Set/Reset button is to reset (remove administrator)with needle

LOCK the door from outside

LOCK the door from inside

Lock the door with your smartphone app



Lock the door with keypad



(optional)

Lock the door with FOB key



(optional)

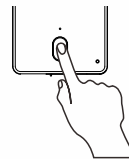

Lock the door with the button from inside

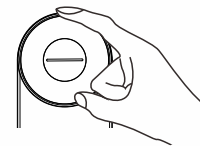

Lock the door with the thumbturn from inside

UNLOCK the door from outside

Unlock the door with your smartphone app



Unlock the door with keypad



(optional)

Unlock the door with FOB key



(optional)

UNLOCK the door from inside

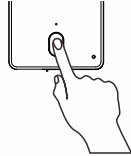

Unlock the door with the button from outside.

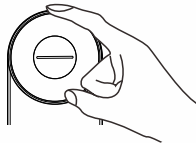

Unlock the door with the thumbturn from inside

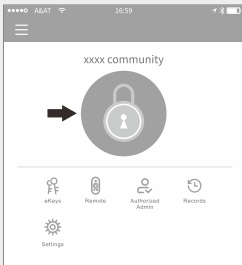

Via APP  
Long press "🔒" to LOCK the door from outside or inside.  
Click "🔓" to UNLOCK the door from outside or inside.

Note: Please keep your phone near the door lock within 32.8ft(10m).

# APP Guide

## A Download APP "TTLock"



Android Mobile Phone--Search "TTLock" from Google Play.  
Apple Mobile Phone--Please search "TTLock" from App Store.

## B Register a new account(phone number or email)

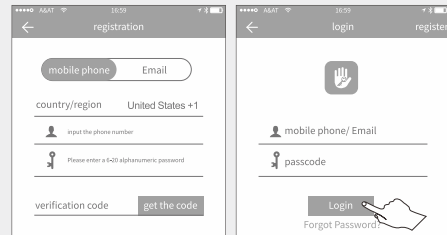
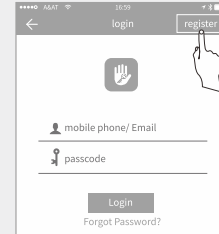



## C Lock adding

- a Turn on Bluetooth and enter the interface of adding door lock in app.

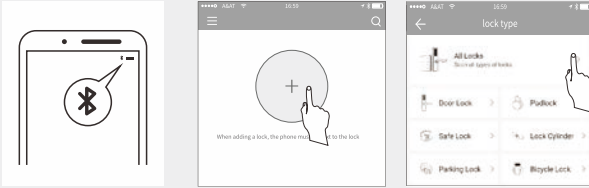

- b Short press Set/Reset button is to match bluetooth with needle (blue light flashing with a sound )

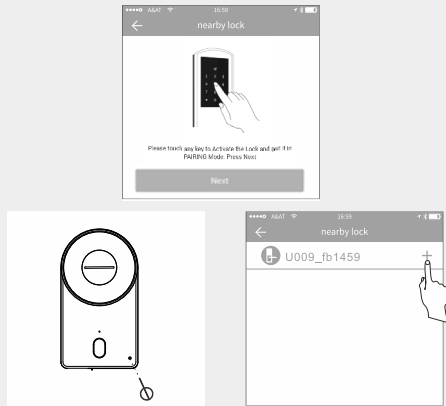

Note: Please keep your phone near the door lock within 2 meters.

## D Deleting account of administrator

Click the lock you want to remove administrator, select SETTING-DELETE PS: All the password will be failed after reset.

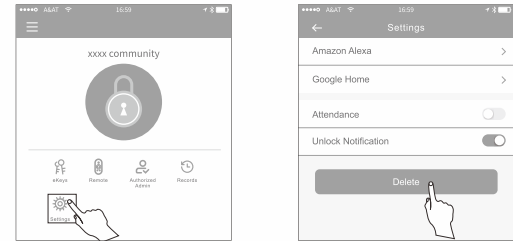

Select  
"Settings"  
in the APP

Select "Delete"  
and insert user  
login password

## E Settings of door opening direction

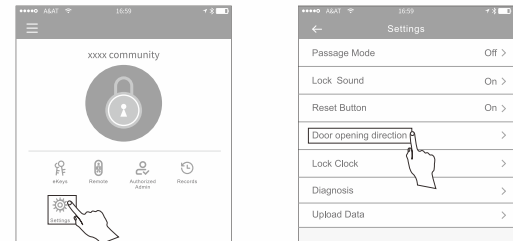

Select  
"Settings"  
in the APP

Select  
"Door opening direction"



Choose "open to right" or "open to left"

## F Add a keypad (optional)

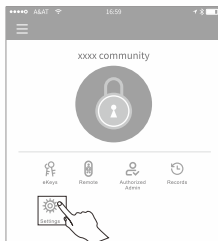

Select "Settings" in the APP

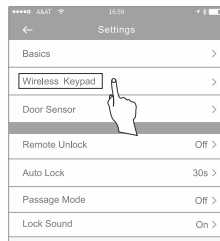

Select "Wireless Keypad"

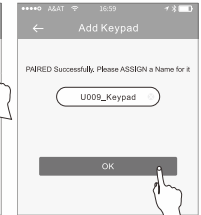
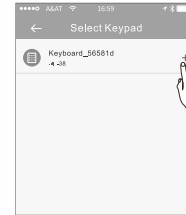

1. Input "\*529#", link the keypad, confirm the information and select OK, back to the main interface of app to use passcode to unlock.
2. Virtual passcode: You can input any number (16-digit limited) before the correct passcode input.

## G Delete the keypad

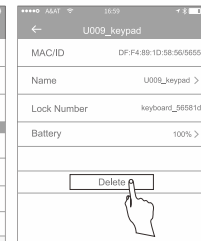
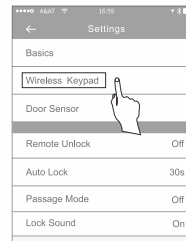
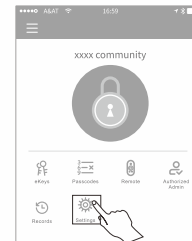

## H Generate passcode(for keypad)

Click "passcodes" in the APP----choose type of passcode: permanent/timed/ontime/custom/Recurring/Eraser----click get passcode.

Eraser is to delete all the passcode having taken effect except administrator passcode.

## a Permanent passcode

The permanent passcode must be used within 24 hours after it is generated, otherwise it will automatically expire.

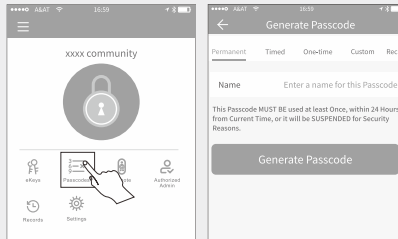

## b Time-limited passcode

The time-limited passcode can own an expiration date, which is a minimum of one hour and a maximum of three years. If the validity period is within one year, the time can be accurate to the hour; if the validity period is more than one year, the accuracy is month when the time-limited passcode is valid, it should be used within 24 hours, otherwise it will automatically expire.

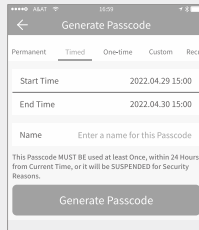

## c One-time passcode

One-time passcode can only be used for onetime, and which is available for 6 hours. It will automatically expire.

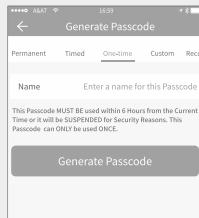

## d Custom passcode

You can Configure your own Passcode. It needs to be between 6- 9 Digits in Length. You can Configure the Customized Passcode via Bluetooth or Remotely via a Gateway.

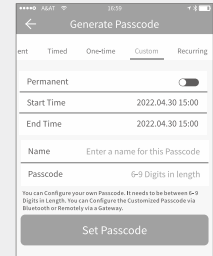

## e Recurring passcode

The Recurring password can be reused within a specified time period, including daily type, weekday type, weekend type, and more.

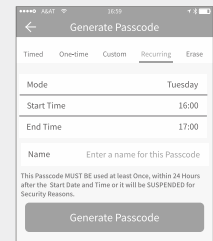

## f Erase passcode

Erase Passcode is VALID for 24 Hours from the Current Time. Caution -All Passcodes used on this Lock will be DELETED on using this Passcode.

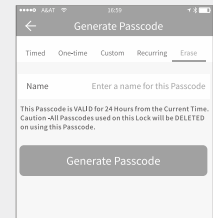

## g Change Password

Click---passcodes---choose the passcode you want to modify---click passcode---input new passcode.

Note: Operation should be done next to the door.

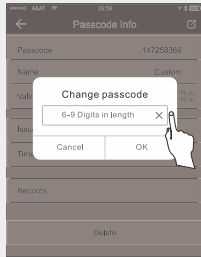
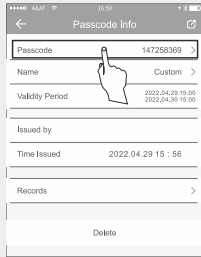

**h** Delete passcode

APP----passcodes----choose the passcode you want to delete.

Note: Operation should be done next to the door.

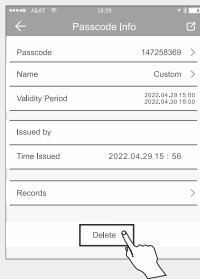

**i** Rename a passcode

APP----passcodes----choose the passcode you want to rename--input a new name.

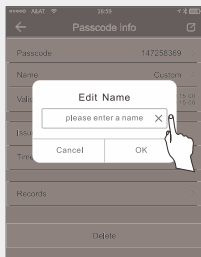
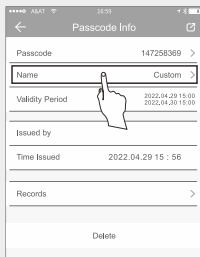

**j** Modify time restrictions of the passcode

APP----passcode ----choose the passcode you want to revise the validity period---input new period----save.

Note: Operation should be done next to the door.

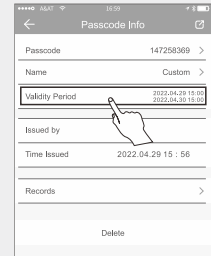

**I** Remote (optional)

**a** Add a remote

APP----Remote----Add Remotes----choose type of remote(Permanent/timed/Recurring)-----fill the information--OK. Long press remotes' lock button for 5 seconds, and then finish adding.

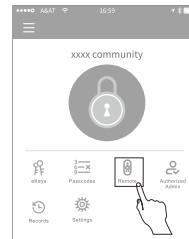

Click Remote

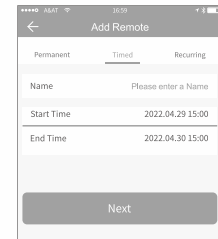

Choose type of Remote

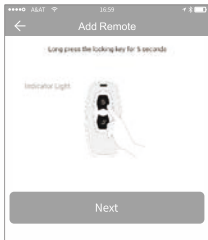

Press and hold the remote locking key for 5S

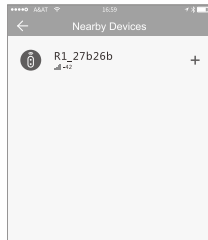

Add the displayed remote

### b Delete remote

APP---Remote---choose the remote you need to delete.

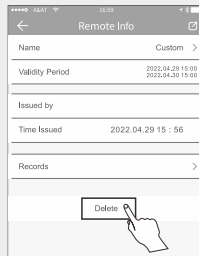

### c Modify the validity period of remote

APP---Remote---Click "validity period" to modify.

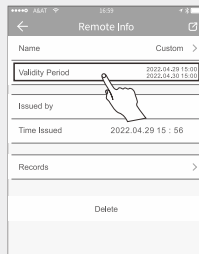

### d Rename the remote

APP---Remote---Name---Fill in the new name

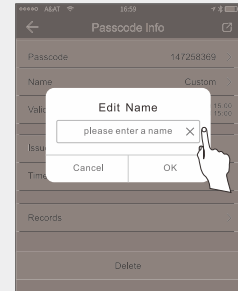
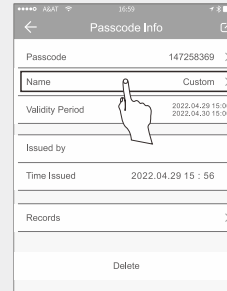

## J eKeys management

### a Sending eKeys

APP---eKeys---send the eKey to the other user. You can authorize the eKey and make it to be the secondary administrator

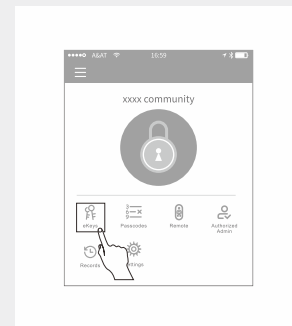

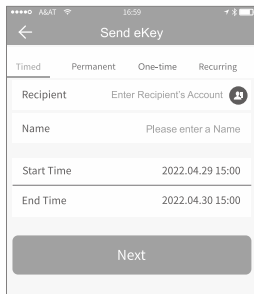
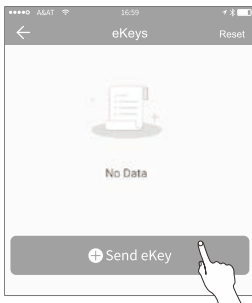

choose ekey's tpye and print other users' account

**b** Delete eKey

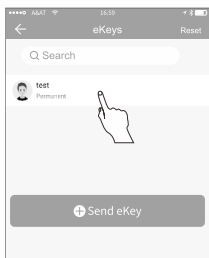

Choose the eKey you want to delete

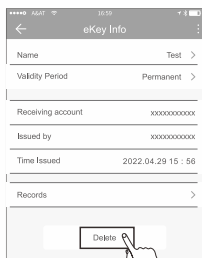

Click "delete"

**K** Door Sensor(extra purchase)

Door will be locked after detecting Sensor change. You can check the state of door lock in the APP after installing the wireless sensor and gateway. Door Sensor will detect the opening direction automatically when being installed.

**a** Add door sensor

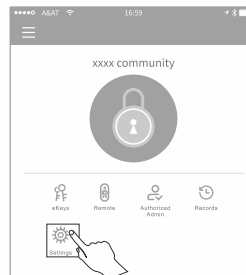

Click "Settings"

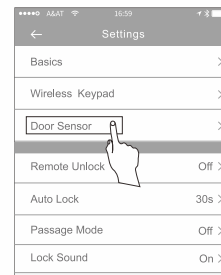

Select "Door Sensor"

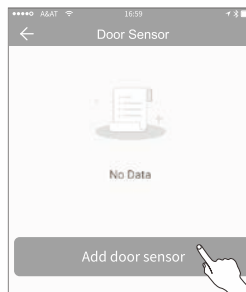

Click "Add door sensor"

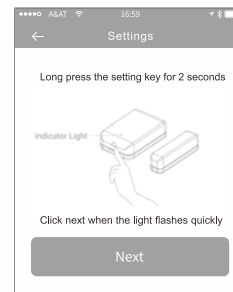

Long press the setting key for 2s, then click "Next"

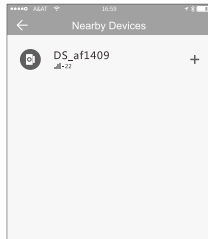

Add the displayed door sensor

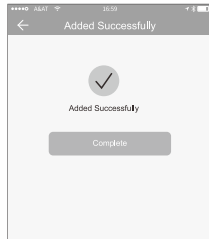

Complete

## b Delete door sensor

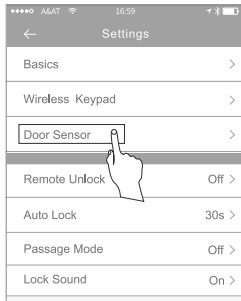

Select "Door Sensor"

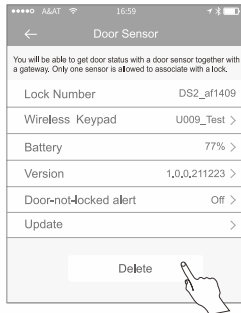

Click "Delete"

## L Gateway management (extra purchase)

The Smart lock is directly connected via Bluetooth, that is why it is not attacked by the network. The gateway is a bridge between smart locks and home WiFi networks. Through the gateway, the user can remotely view and calibrate the lock clock, read the unlock record. Meanwhile, it can remotely delete and modify the password.



Gateways are added via an app before they can be used. Here are the steps:

- (1) open the TTLOCK APP;
- (2) Touch the "☰" icon on the top left of the screen;
- (3) Select [Gateway];
- (4) select the "G2";
- (5) Plug in the Gateway and power it on;
- (6) While the light is flashing alternately in red and blue, press "+" sign;
- (7) Add Gateway;
- (8) Select the network and input your WiFi password

**⚠ Notice: If the above process times out, please power off and try again.**

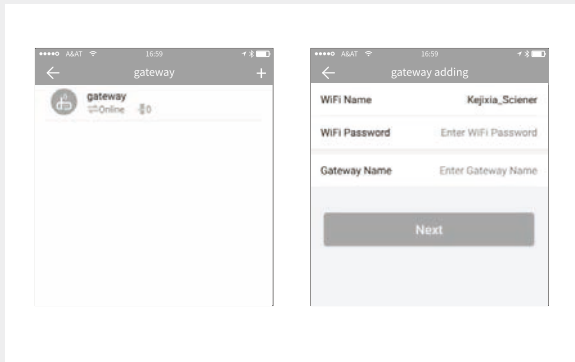

## M Records

It records who comes and goes, and when for 24/7 access logs, get all records about the door unlock/lock anytime and anywhere.

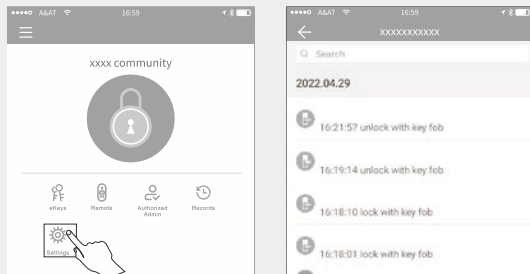

Note: The records will not be checked without the bridge. You can keep track of who has locked or unlocked via app on your mobile phone.

## N Firmware Update

App---Settings---Firmware Update--- to update your firmware.  
Note: Operation should be done next to the door.

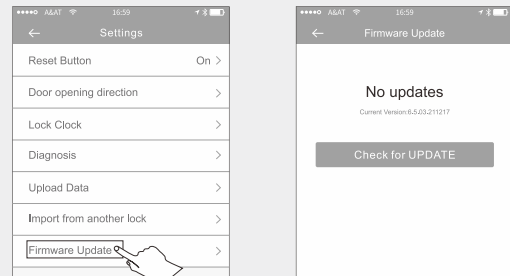

Select "Firmware Update"

Check for update

## O Auto Re-lock Mode

Auto Re-lock Mode can be set up in APP.(5s,10s,15s, 30s,60s,Custom) When the lock is unlocked via APP, passcode or RFID card, it will re-lock automatically in the reset time.

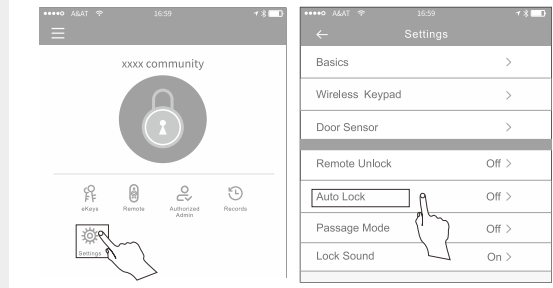



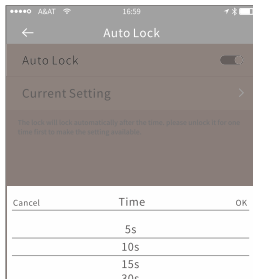
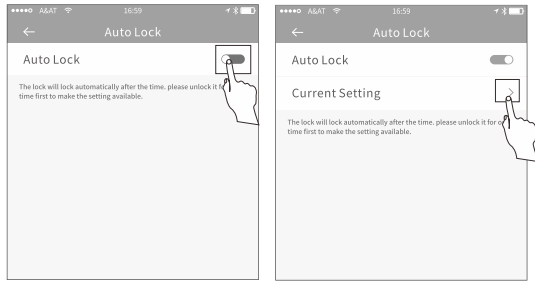

## Low Power

Unlock the door  
from inside or  
outside



"Beep" to warn



Low Power

When the battery voltage is lower than 4.8V, the buzzer will sound "Di Di Di" after unlocking

## Restore Factory Settings

### Restore on APP

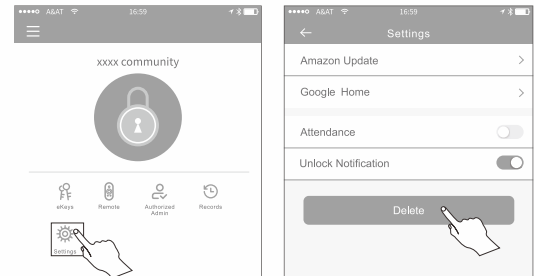

## Restore on lock

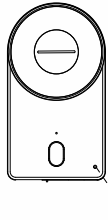

Use needle and long press the button as photo, sound "DI DI", lock will be restore and remove administrator.

## Troubleshooting

### **The turnpiece cannot rotate or operate the lock.**

Remove and re-install the lock, making sure that the turnpiece is in right position.

### **The lock cannot connect APP via bluetooth**

Please make sure the bluetooth is on. The APP is ready to search the lock. If needed, restore the lock's default setting.

### **Multiple attempts unlock the door also failed to open**

Use the key to open the lock and change the battery. If needed, please contact customer service.

## Appendix

